

SWAGTRON® USER MANUAL

Ver. 1.0 01/21

In order to continue serving our customers and providing the best products, our product information including our user manuals may receive updates from time to time. Please check our website for the latest user manuals and product materials.



SWAGGER 5 BOOST
FOLDING ELECTRIC SCOOTER

I. GENERAL INFORMATION

- 1.1. Important Information 01
- 1.2. Safety Warnings 02
- 1.3. Disposal at End-of-Life 03
- 1.4. FCC Information 04

II. PARTS & FEATURES

- 2.1. What's in the Box? 05
- 2.2. Swagger 5 Boost Diagram 06
- 2.3. Display Information 07

III. FOLDING & ASSEMBLY

- 3.1. Assembling the Handlebars 07
- 3.2. Standing, Folding & Unfolding the Scooter. 08
- 3.3. Tire Inflation 09

IV. CHARGING 10

V. USAGE

- 5.1. How to Ride 12
- 5.2. Practicing Guidelines 13
- 5.3. How to Pair. 14

VI. MAINTENANCE

- 6.1. Cleaning 15
- 6.2. Storage 16
- 6.3. Transportation 16

VII. SPECIFICATIONS 17

VIII. 90-DAY LIMITED HARDWARE WARRANTY 18

I. GENERAL INFORMATION

Before operating this vehicle, please read all instructions. This manual will guide you through the functions, usage, and proper care of your Swagger 5 Boost Folding Electric Scooter. If you have any questions or cannot find the information you need in the manual, please contact your place of purchase or our customer service at 1-844-299-0625. Before contacting customer service, please have your purchase information ready as this may be needed during the call. This information may be recorded below.

Date of Purchase:

Place of Purchase:

It is important that you follow all safety warnings that appear throughout this manual and exercise good judgment when using your Swagger 5 Boost scooter. Consult this manual before you attempt to use your Swagger 5 Boost.

1.1. Important Information

Within this manual, “the Swagger 5 Boost”, “your Swagger 5 Boost”, “your scooter” and “the scooter” refer to the Swagger 5 Boost Folding Electric Scooter. The Swagger 5 Boost is a personal scooter that uses electrical power. By riding the Swagger 5 Boost, the user acknowledges and accepts responsibility for all risks associated with the use of the Swagger 5 Boost which may include, but are not limited to, muscle injuries, broken bones, lacerations, serious injury, and possible death.

To better insure your safety, **ALWAYS USE APPROPRIATE PROTECTIVE GEAR**, read and follow all instructions and warnings in the User Manual.



Appropriate protective gear should include shoes, kneepads, elbow pads and an ASTM F1492 approved helmet.

1.2. Safety Warnings

When reading this manual, note these icons:



Notes with this icon **MUST** be read, understood, and obeyed to prevent injury or damage, etc.



Notes with this icon include relevant information.



- Do not place the battery in fire or direct contact with heat or sunlight.
- Avoid using or storing the scooter and/or battery in extremely hot or extremely cold environments. Using or storing the battery in extreme temperatures may cause it to become hot or to break and/or reduce battery performance or life expectancy.
- Do not subject the battery to strong impact or shock.
- Risk of shock. Do not allow water and/or liquids to enter the scooter's electric parts. If cleaning is needed, dampen non-abrasive cloth with water or mild cleaner and wipe off the scooter.
- Never submerge the scooter or any of the scooter's components.
- Do not disassemble or modify the battery. Attempting to repair or modify your battery voids all warranties. Only authorized repair centers may open and service the battery.
- If the device is to be used by children, the caregiver should explain the contents of the user manual to the children. The caregiver should provide adequate supervision to ensure that the device is being used as explained in the user manual.
- Immediately discontinue use of the battery if, while using, charging, or storing the battery, the battery emits an unusual smell, feels hot, changes color, changes shape, or appears abnormal in any other way.
- In the event that the battery leaks and the fluid gets into one's eye, do not rub the eye. Rinse well with water and immediately seek medical care.



- Use only the charger provided with your scooter. If you have lost or misplaced your charger, contact customer support to obtain a replacement.
- Do not continue charging the battery if it does not recharge within the specified charging time. Disconnect the scooter from the charging cable and contact customer service.
- Keep your charging environment clean and dry at all times.
- If the charging port is damp or has any liquid on it, DO NOT charge your scooter.
- Avoid charging in extremely hot or extremely cold environments. Charging the battery in extreme temperatures may cause it to become hot or to break and/or reduce battery performance or life expectancy.
- Do not discharge the battery using any device except for the Swagger 5 Boost Folding Electric Scooter.

1.3. Disposal at End-of-Life

This product must not be disposed of by incineration, landfilling, or mixing with household trash. Improper disposal of the battery contained within this product may result in the battery heating up, rupturing, or igniting which may cause serious injury. The substances contained inside the battery present chemical risks to the environment. The recommended disposal for any Swagger 5 Boost Folding Electric Scooter at its end-of-life is to dispose of the entire unit at or through an e-waste recycling center, program, or facility. Local regulations and laws pertaining to the recycling and disposal of lithium-ion batteries and/or products containing them will vary according to country, state, and local governments. You must check laws and regulations corresponding to where you live in order to dispose of the battery and/or unit properly. It is the user's responsibility to dispose of their waste equipment properly in accordance with local regulations and laws.

For additional information about where you should drop off your batteries and electrical or electronic waste, please contact your local or regional waste management office, your household waste disposal service, or your point-of-sale.

1.4. FCC Information

DECLARATION OF CONFORMITY:

This device complies with Part 15 of the FCC Rules.

Operation is subject to the following two conditions: (1) This device may not cause harmful interference, and (2) this device must accept any interference received, including interference that may cause undesired operation.

FCC RELATED INFORMATION:

This equipment has been tested and found to comply with the limits for a Class B digital device, pursuant to Part 15 of the FCC Rules. These limits are designed to provide reasonable protection against harmful interference in a residential installation. This equipment generates, uses, and can radiate radio frequency energy and, if not installed and used in accordance with the instructions, may cause harmful interference to radio communications. However, there is no guarantee that interference will not occur in a particular installation. If this equipment does cause harmful interference to radio or television reception, which can be determined by turning the equipment off and on, the user is encouraged to try to correct the interference by one or more of the following measures:

- Reorient or relocate the receiving antenna.
- Increase the separation between the equipment and receiver.
- Connect the equipment into an outlet on a circuit different from that to which the receiver is connected.
- Consult the dealer or an experienced radio/TV technician for help.

The manufacturer is not responsible for any radio or TV interference caused by unauthorized modifications to this equipment. Such modifications could void the user's authority to operate the equipment.

II. PARTS & FEATURES

Please read the user manual in its entirety before using the Swagger 5 Boost so that you may fully understand its parts and functions and be able to operate it safely.

2.1. What's in the Box?

- 1x Swagger 5 Boost Folding Electric Scooter
- 1x Charger
- 1x Bottle Holder
- 2x Cable Ties*

*If using either cable tie, do not overtighten as this may cause the ties to break

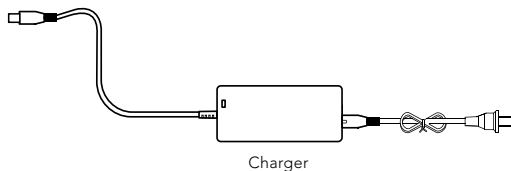

Swagger 5 Boost Folding Electric Scooter

2.2. Swagger 5 Boost Diagram

1. Handles
2. Brake
3. Bell
4. Lock
5. Display
6. Power Button
7. Throttle
8. Headlight
9. Stem
10. Latch
11. Collar
12. Front Bumper
13. Motorized Front Wheel
14. Deck
15. Charging Port
16. Kickstand
17. Rear Bumper
18. Rear Wheel
19. Hook
20. Taillight

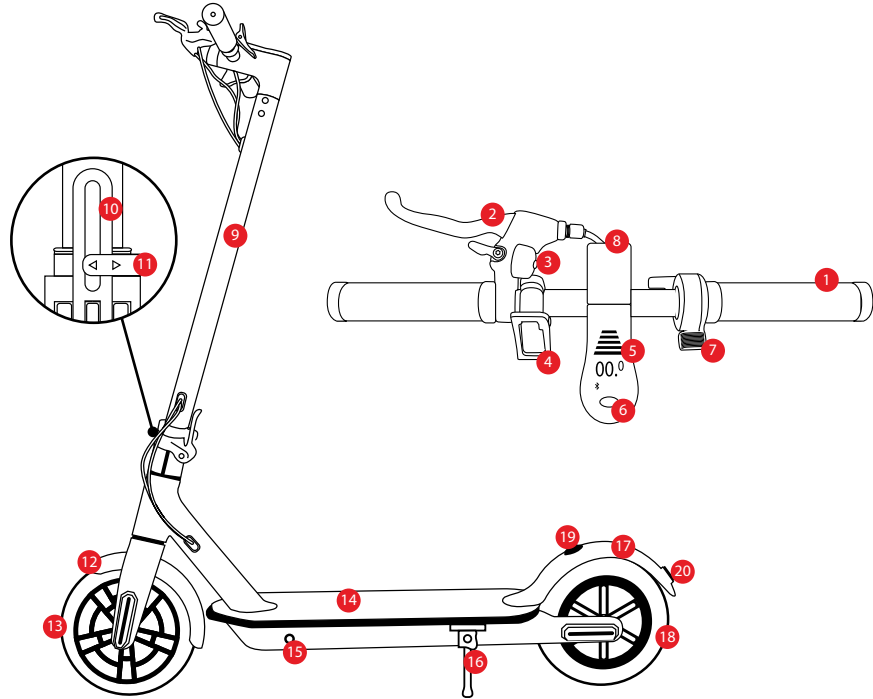

2.3. Display Information

The Swagger 5 Boost's display features several different elements. Be sure you understand these before attempting to ride. Press and hold the power button approx. 3-5 seconds to turn the scooter on/off.

1. **Battery Level Indicator** - This icon indicates how much battery life you have left. As power goes down, the icon will indicate different levels.
2. **Speedometer** - These numbers indicate the current speed and will change when the Swagger 5 Boost is in use. Readings are measured in mph.
3. **Pairing Status Indicator** - This icon indicates pairing status. When it is not visible, this indicates the scooter is connected to your phone. When it is visible and flashing, this indicates the scooter is disconnected from your phone.

 When the battery level is low, stop riding, turn off the scooter, and fully recharge it before riding again.



III. FOLDING & ASSEMBLY

Ensure the Swagger 5 Boost is off before working with any of its parts. The scooter comes mostly assembled within the package. Some minor assembly is required before riding. All parts and tools are included.

3.1. Assembling the Handlebars

First, thread the section with the brake and bell onto the left side of the handlebars, then use an Allen key to tighten the screw underneath it. Next, screw the handles in. Lastly, make sure everything is securely attached.

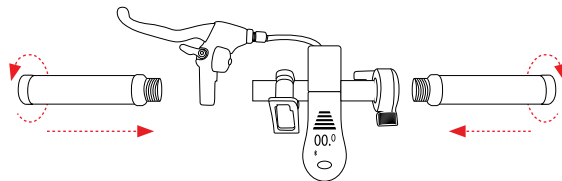

3.2. Standing, Folding & Unfolding the Scooter

Before using the kickstand, bring the scooter to a complete stop and turn it off. Before riding the scooter again, lean the scooter off the kickstand and fold the kickstand up.

Standing

- Step 1. Locate the kickstand on the side of the scooter's deck.
- Step 2. Push the kickstand down and away from the scooter then carefully lean the weight of the scooter onto the kickstand.

Folding

- Step 1. Turn the collar counterclockwise to unlock the latch.
- Step 2. Fold the latch down then pull the stem down towards the deck.
- Step 3. Line up the handlebars with the rear bumper so that the lock connects to the hook.

Unfolding

- Step 1. Move the lock so that it detaches from the hook.
- Step 2. Pull the stem away from the deck.
- Step 3. Fold the latch up towards the stem and turn the collar clockwise to lock it.

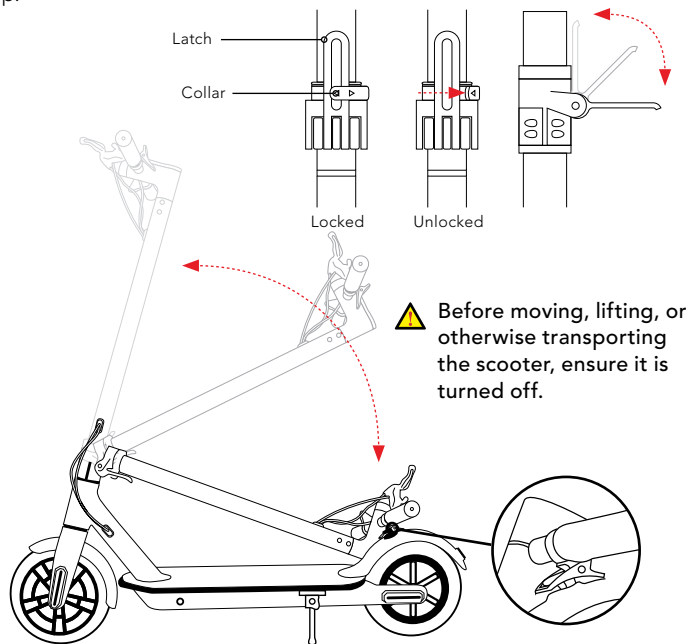

3.3. Tire Inflation

 You will need a pressure gauge, a standard bicycle pump, and the included valve extender to inflate the Swagger 5 Boost's tires.

Step 1. Ensure the scooter is powered off and stable, so it doesn't move during inflation.

Step 2. Visually inspect the tires for damage, scuff, or puncture marks. If the tire is damaged, DO NOT INFLATE IT. Contact customer service immediately.

Step 3. Find the valve located on the inside of the wheel and remove the cap.

Step 4. Use a standard bicycle pump to pump air to the tire slowly.

Step 5. Use the pressure gauge periodically to check PSI.

Step 6. When the tire reaches 28 PSI / 1.9 BAR, stop inflating and replace the valve cap.

Step 7. Repeat with the other tire.

-  • Any PSI marking on the tires themselves indicates a maximum. DO NOT inflate the tires to this value, only inflate them to 28 PSI as directed above.
- As with all air-filled tires, underinflation is strongly recommended if you intend to ride outdoors in temperatures above 90°F degrees. Bring the Swagger 5 Boost indoors and deflate the tires to 25.2 PSI. If the PSI is too high and the tires are exposed to excessively high temperatures, riding outdoors may cause serious damage to the tire including but not limited to stretching and/or rupturing.

IV. CHARGING

 **Charge the Swagger 5 Boost before using it.**

The charge cycle is complete when the battery indicator on display is full. Each charge cycle from zero to full charge will take approximately 3.5 hrs. When the backlit display on the handlebars indicates that battery power is low, recharge the Swagger 5 Boost. To recharge the Swagger 5 Boost, use the included charger.

Step 1. Make sure the scooter is powered off then locate the charging port under the deck.

Step 2. Insert the appropriate end into the charging port and then insert the other end into an outlet.

Step 3. While the scooter is charging, the charger light will turn red.

Step 4. When the scooter is fully recharged, the charger light will turn green. You may then disconnect the scooter from the charger.

 **DO NOT, under any circumstances, use the scooter while it is charging or connected to the charger.**

 The charging time is approximately 3.5 hours. Charging longer than that may affect battery life and/or performance. If the charger's light doesn't turn on, it may not be fully connected. Check that it is securely connected to the wall and to the scooter.

V. USAGE

We sincerely hope every operator can ride the Swagger 5 Boost safely. Note the following information before attempting to ride your Swagger 5 Boost.

- ⚠ • An ASTM F1492 approved helmet as well as other protective gear must be worn at all times
 - The Swagger 5 Boost supports up to 320 lbs (145 kg).
 - Before each ride, especially if you may travel a long distance, check the tires for proper inflation, check all cables for damage, and test the brakes. Do not ride if any part of the scooter is damaged or malfunctioning.
 - Only operate the Swagger 5 Boost where permitted. Local laws may restrict where you may ride.
- 📄 • The Swagger 5 Boost contains a motor and may be classified as a motor vehicle under local laws in your area. It is your responsibility to understand and abide by any local laws restricting how or where you may ride.

5.1. How to Ride

Assuming you have equipped suitable protective gear and that the Swagger 5 Boost has been placed on a level surface, is charged, and does not have any issues, follow the steps below. For your safety, please read this entire section before attempting to ride.

- Start your scooter by pressing and holding the power button for 3~5 seconds.
- Moving forward with your scooter is as easy as pressing the throttle.
- Cruising is as simple as maintaining speed for at least 5 seconds.
- Use the bell to alert pedestrians and other riders of your presence.
- Turn the headlight on/off by quick-pressing the power button twice.
- Switch gears between 1, 2, and 3 by quick-pressing the power button once. Each gear has different speed. Gear 1's max. is 5 mph, Gear 2's is 10 mph, and Gear 3's is 18 mph.
- The display shows how much battery power is left.
- To slow down, gradually ease off the throttle and apply pressure to the brake.
- To stop, apply full pressure to the brake until the scooter stops completely.

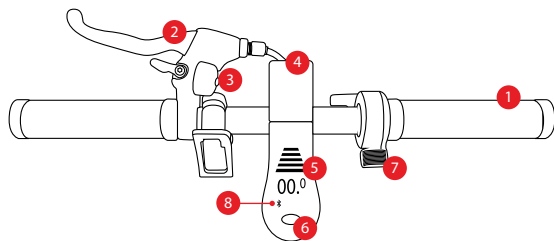

- | | |
|--------------|----------------------|
| 1. Handles | 5. Display |
| 2. Brake | 6. Power Button |
| 3. Bell | 7. Throttle |
| 4. Headlight | 8. Pairing Indicator |



- When the headlight is turned on, the taillight will also blink for increased visibility.
- Gear speeds are approximate. Actual speed may vary due to terrain, rider weight, and/or other factors.

Step-by-Step

Step 1. Carefully step on with one foot and stand upright but relaxed. Grab both handles.

Step 2. Keep one foot on the ground and kick off to begin accelerating manually. Use the handles to steer.

Step 3. To stop, release the throttle and use the brake to gradually coast to a stop then step off the scooter one foot at a time. Be extra cautious when dismounting for the first time. When using the brake, the taillight will turn red automatically.

Step 4. To turn the scooter off, remain at a complete stop and press and hold both the handbrake and throttle for at least two seconds. The display and lights will turn off as the scooter powers off.

Cruise Control

Step 1. Accelerate to reach the desired speed.

Step 2. Hold the throttle for approx. 5 seconds to turn on Cruise Control and maintain speed.

Step 3. Use the throttle or the brake to turn off Cruise Control.

5.2. Practicing Guidelines

Practice until you are comfortable with using all of the scooter's functions. See the following tips below.

- Wear casual clothing and flat, closed-toe shoes to maintain your flexibility and stability.
- Practice until you can easily get on, move forward, turn, stop, and dismount with ease.
- Make sure the pavement is even. Do not operate on a slope until you are experienced.
- The Swagger 5 Boost is designed for relatively smooth, flat terrain. When driving on uneven terrain, slow down.
- Until you are comfortable using the scooter, avoid operating in places with pedestrians or obstacles.

5.3. How to Pair

If desired, the Swagger 5 Boost can be paired with your phone for app connectivity. The app is compatible with most Android and iOS smartphones and grants full access to additional features.

Step 1. Use your smartphone to search the Play or App Store for the “Swagger” application.

Step 2. Download and install the app then open it and create an account and/or log in.

Step 3. Turn on your smartphone’s Bluetooth® function and tap “OK”. The phone will automatically begin searching for the scooter.

Step 4. Power on the scooter to automatically turn on Bluetooth® and make it discoverable.

Step 5. Once the app finds the scooter, tap “Pair” to connect the two. After successfully pairing the two, the scooter’s pairing indicator will stop flashing.



Step 6. After successfully pairing, use the app and scooter as desired.

Step 7. To disconnect the devices, turn off your smartphone’s Bluetooth® function.

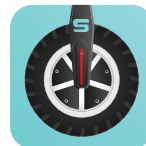
- ⚠ • Powering on the Swagger 5 Boost will automatically enable Bluetooth® i.e. Bluetooth® will become enabled and stay enabled as long as the scooter is powered on.
- Please check your smartphone’s instructions for any issues turning the Bluetooth® function on or off.
- As with most Bluetooth® devices, it is recommended to keep the connected devices within a reasonable distance from one another. The connection may be terminated or fail to work properly if the connected devices are too far apart.



VI. MAINTENANCE

-  Do not perform any maintenance when the power is on, or the battery is charging. Do not let water or liquids get into the scooter as this will cause permanent damage to the electronic components.
- **After each ride, especially if you have traveled a long distance, inspect your scooter.**
 1. Check the tires for proper inflation and cracks on the walls of the tires. Proper inflation is 28 PSI / 1.9 BAR. Keeping the tires properly maintained will help prevent flats and damage. For inflation instructions, see Section 3.4.
 2. Inspect the brakes to make sure that both are working properly.
 3. Make sure all screws and bolts are taut and properly fastened to prevent injury and unnecessary wear and tear.
-  For questions, concerns, or part replacement, please contact customer service.

6.1 Cleaning

The Swagger 5 Boost may need cleaning after riding for extended periods of time. See the following tips below.

- Completely power off the scooter before cleaning.
- Use dry, non-abrasive cloth to gently remove debris or dust.
- If needed, dampen cloth with water or a mild cleaner and wipe off the scooter.
- Never use alcohol or ammonia-based cleaning solutions.
- Never spray liquid directly onto any part of the scooter.
- Do not allow any type of liquid to come in contact with the scooter's electronic parts.

6.2 Storage

- Before storing the scooter, fully charge it to prevent battery over-discharge due to non-use.
- If storing the scooter for more than one month, discharge and recharge the battery every three months.
- Cover the scooter to protect it from dust. Do not store in a dusty environment as, with all electronic devices, this may cause damage over time.
- DO NOT store the scooter in an unheated garage, shed, or other location with extreme temperature fluctuations or ranges. Store only in environments where temperatures will be stable and kept between -4°F to 140°F (-20°C to 60°C).

6.3 Transportation

Before moving, lifting, or otherwise transporting the scooter, turn it off. Fold the scooter (see Section 3.3 for instructions) and pull the scooter along as you move it if needed.

- 📖 When lifting the entire scooter, please note that the Swagger 5 Boost weighs approximately 26 lbs (11.8kg). If you are unsure of your ability to lift this weight, please use both hands or have a second person help.

VII. SPECIFICATIONS

Indicators	Items	Parameters
Dimensions	Folded Size	41.5 x 17 x 19 in (1054 x 436 x 480 mm)
	Opened Size	41.5 x 17 x 45.3 in (1054 x 436 x 1150 mm)
Weight	Vehicle Weight	About 26 lbs (11.8 kg)
Riding Requirements	Suitable Heights	4' - 6'6" (120 - 200 cm)
	Weight Limit	44 - 320 lbs (20 - 145 kg)
	Speed	18 mph (29 km/h) *Based on Terrain & Rider Weight
	Range per Charge	11 mi (17.7 km)
	Suitable Terrain	Hard Surfaces, Flat roads, Ramps under 20°
	Working Temp.	32°F to 109°F (0°C to 43°C)
	Storage Temp.	-4°F to 140°F (-20°C to 60°C)
Motor	Power	300W
Tires	Front Tire	Rubber, Motorized Wheel, Air-Less Honeycomb Design
	Rear Tire	Rubber, Passive, Air-Less Honeycomb Design
Battery	Battery	Rechargeable Lithium-Ion
	Battery Management	Balance, Over-charge, Under-voltage, Overheating, Automatic Shutoff
	Voltage	37V
	Watt Hours	270
Charger	Input Voltage	100-240V 50/60Hz
	Output Voltage	42V 2A 
	Charging Time	~3.5 hours

VIII. 90-DAY LIMITED HARDWARE WARRANTY

Your SWAGTRON® Swagger 5 Boost Folding Electric Scooter (“Product”) includes a 90-Day Limited Hardware Warranty (“Warranty”). The Warranty covers product defects in materials and workmanship under normal use. This Warranty is limited to residents of the United States (Excluding Hawaii, Alaska and US Territories) and Canada only and is available only to original purchasers. This Warranty gives you specific legal rights and you may also have other rights which vary from state to state.

This Warranty starts on the date of your purchase and lasts for 90 days (the “Warranty Period”). The Warranty Period is not extended if the Product is repaired or replaced. We may change the availability of this limited warranty at our discretion, but any changes will not be retroactive.

Warranty services are provided by SWAGTRON®. If a hardware defect arises and a valid claim is received within the Warranty Period, at its option and to the extent permitted by law, SWAGTRON® will: (1) repair the hardware defect by using new or refurbished parts that are equivalent to new in performance and reliability; or (2) exchange the Product with a product that is new or refurbished which is substantially equivalent to the original product. This Warranty is for one replacement only of like-items and does not cover items out of production if the product is no longer made or stocked. This Warranty is not assignable or transferable. The original purchaser may call SWAGTRON’s toll-free number at 1-844-299-0625 for service request.

When a product or part is exchanged, any replacement item becomes your property and the replaced item becomes SWAGTRON®’s property. This warranty only covers technical hardware defectiveness during the warranty period and under normal use conditions. SWAGTRON® does not warrant uninterrupted or error-free operation of this Product.

Return shipping shall only be provided for Products dead on arrival (“DOA”) within 30 days of purchase only. All other returns/repairs shall require payment of shipping cost at discounted rate to be determined as follows:

SWAGTRON® E-Scooters, and Hoverboards shall be Twenty Dollars (\$20)**

SWAGTRON® K-Line shall be Eight Dollars (\$8)**

**shipping prices are subject to change with further notice.

This Warranty does not cover any damage due to: (a) transportation; (b) storage; (c) improper use; (d) failure to follow the product instructions or to perform any preventive maintenance; (e) modifications; (f) unauthorized repair; (g) normal wear and tear (including but not limited to wearables and other consumable parts such as tires); or (h) external causes such as accidents, abuse, or other actions or events beyond our reasonable control.

Important: Do not disassemble the Product. Disassembling the Product will void this Warranty. Only SWAGTRON® or a party expressly authorized by SWAGTRON® should perform service on this Product.

DISCLAIMER OF WARRANTY: THE REMEDIES DESCRIBED ABOVE ARE YOUR SOLE AND EXCLUSIVE REMEDIES AND OUR ENTIRE LIABILITY FOR ANY BREACH OF THIS LIMITED WARRANTY. OUR LIABILITY SHALL UNDER NO CIRCUMSTANCES EXCEED THE ACTUAL AMOUNT PAID BY YOU FOR THE DEFECTIVE PRODUCT, NOR SHALL WE UNDER ANY CIRCUMSTANCES BE LIABLE FOR ANY CONSEQUENTIAL, INCIDENTAL, SPECIAL OR PUNITIVE DAMAGES OR LOSSES, WHETHER DIRECT OR INDIRECT.

SOME STATES DO NOT ALLOW THE EXCLUSION OR LIMITATION OF INCIDENTAL OR CONSEQUENTIAL DAMAGES, SO THE ABOVE LIMITATION OR EXCLUSION MAY NOT APPLY TO YOU.

THE DURATION AND REMEDIES OF ALL IMPLIED WARRANTIES, INCLUDING WITHOUT LIMITATION THE WARRANTIES OF MERCHANTABILITY AND FITNESS FOR A PARTICULAR PURPOSE ARE LIMITED TO THE DURATION OF THIS EXPRESS LIMITED WARRANTY.

SWAGTRON®

Copyright © 2021 swagtron. All rights reserved.